



Super Adaptability

Upper arm, boom swing, tailless, track switching, more than ten kinds of attachments









Improved Stability

Built-in pipeline, oil cylinder protection, telescopic chassis

Improved Comfort

High-back seat, improved control system





PERFORMANCE PARAMETER

	Model	KP20-8
	Bucket capacity	0.05 m ³
	Engine model	Perkins 403D-11
	Engine power	14.7/2200 kW/rpm
	Max. gradeability	30°
	Max. arm digging force	10.1 kN
	Max. bucket digging force	15 kN
	Travelling speed	4.5/2.5 km/h
	Slewing speed	8.5~10.5 rpm

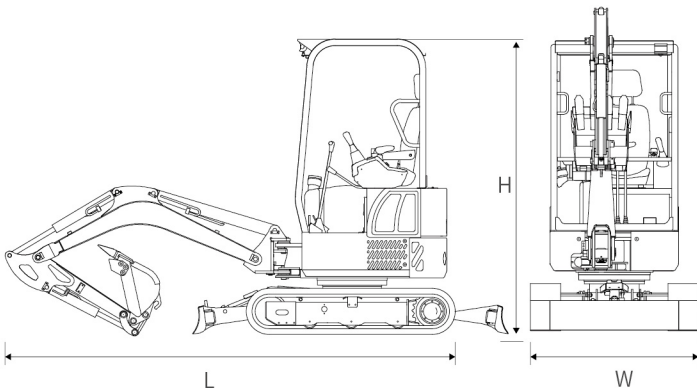

Dimension and Weight



DIMENSION		KP20-8
	Overall length (L)	mm 3606
	Overall width (W)	mm 980/1280
	Overall height (H)	mm 2210
	Machine weight	kg 1785 ^① /1850 ^②

①: With rubber track, ②: With steel track.

KEYPOWER has the right to modify any feature without prior notice. Weights and dimensions based on standard products. Illustrations may include optional equipment. Technical data described in this catalogue correspond to the available information at the moment of printing. The illustrations and images are indicative and may not coincide in their entirety with the product. Industrial design under patent.

Technical Specifications

OPERATING PARAMETER	KP20-8
Max. digging height	3456 mm
Max. digging depth	1755 mm
Max. digging radius	3953 mm
Max. ground digging radius	3955 mm
Max. dumping height	2178 mm
Min. swing radius (Front end)	1700 (1495) mm
Max. vertical digging depth	1474 mm

OTHER PARAMETER	KP20-8
Track pad width	230 mm
Overall length of crawler	1642 mm
Minimum ground clearance	175 mm
Balance weight ground clearance	445 mm
Tail swing radius	775 mm
Fuel tank capacity	18 L
Hydraulic oil tank capacity	20 L

Product Structure



KP20-8 Details

Dozer shovel large protection plate, pipeline layout protection, chassis hose protection, control box, instrument, waterproof and dustproof switch LED light, super flexible pilot tube



■ Molded Fuel Tank



■ Full Pilot Control

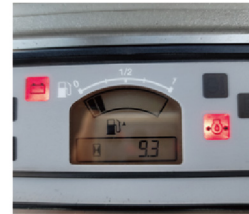

■ Intelligent Instrument



■ LED Lights



■ Pedal, comfortable and anti-fatigue



■ Adjustable dozer shovel

A large variety of attachments for different applications

More than ten types of attachments

Hydraulic hammer, bucket, quick change device, log grabber, simple grab pliers, ditch clearing bucket, clamshell bucket, drilling tool, lawn mower, etc. More than 40 key working conditions are applied, with a wide range of working conditions. Various accessories, easy to change orchard planting, rural reconstruction, engineering construction, greenhouse breeding, road crushing, digging ditches and repairing canals, drilling holes and planting trees.

Bucket



Log grapple



Narrow bucket



Twist drill



KEYPOWER
 Attachments

Breaker



Quick coupler



Scarifier



Garden rake



KP20-8 Features and Advantages

Power System



- Perkins Engine (Other engine brands available)
- 30% larger engine power reserve
- Capable of handling plateau conditions without supercharging
- Power/speed 14.7/2200 (kW/rpm)
- Maximum torque/ speed 62~66.8Nm/ 1800rpm
- Aluminum, oil-dispersed, water-dispersed parallel radiator

Control System



- **Load sensing system**
 Load sensing control system with lower power loss and much higher efficiency than conventional hydraulic systems
- Movement is light, quick, powerful, coordinated and efficient
- High efficiency, low power loss results in fuel savings and lower heat generation in the hydraulic system
- Original imported hydraulic system (optional): nachi-pump, nabtesco-valve, eaton-rotary motor

Operating System



- **Full pilot control**
- The driving experience is more comfortable and the excavator moves more smoothly

Travel System



- **The boom can be swung left and right**
- Max. boom-swing angle (L) **42°** / Max. boom-swing angle (R) **75°**
- In order to improve the flexibility of the excavator bucket, reduce the space required for its work, so that the bucket can rotate while the body and boom remain stationary

Travel System



- Replaceable Tracks
- Rubber tracks are used by default, steel tracks can be replaced without changing the rollers

Travel System



- Telescopic chassis
- The narrowest chassis can be retracted to **980mm** and stretched to **1280mm**, which allows the excavator to pass through narrow passages

Load Sensing System



Load Sensing System schematic diagram

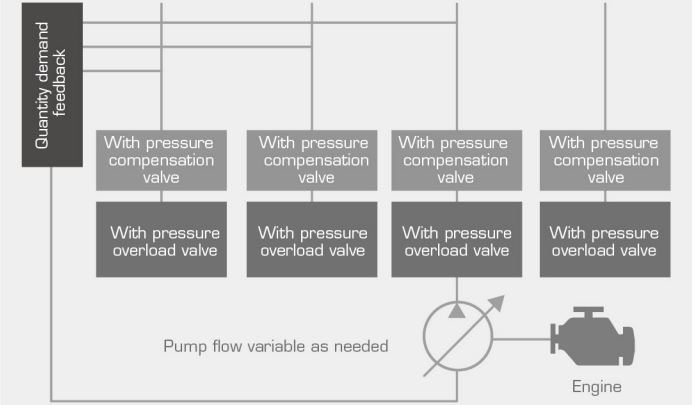

Powerful engine and load sensing hydraulic system

14.7 kW (20 HP) engine combined with load sensing hydraulic system and variable displacement pump for excellent excavation performance and smooth control.

The KP20 is compact, does not stall under load, and is ready to deliver a lot of power, so it is very efficient.

Options:



Cab

The cab is more spacious with a better view.
Effective relief of operating fatigue



Emission standard:
Euro V standard



Emission standard:
EPA

